

SiC Schottky Diode

Product Summary

V_{RRM}	1200V
$I_F(T_c 150^\circ\text{C})$	15A
Q_c	62nC

Features

- Low conduction loss due to low VF
- Extremely low switching loss by tiny QC
- Essentially No Switching Losses
- Increased Power Density
- Enabling Higher Switching Frequency
- RoHS Compliant

Applications

- Switch Mode Power Supplies
- Uninterruptible Power Supplies
- Motor Drivers
- Power factor correction

Mechanical data

- Case: TO-247-2L
- pprox. Weight: 6.0g (0.21oz)
- RoHS compliant
- Case Material: "Green" molding compound, UL flammability classification 94V-0, "Halogen-free".

Maximum Ratings

Ratings At 25°C Ambient Temperature Unless Otherwise Specified

Parameter	Symbols	SC15120W	Test Conditions	Units
Maximum Recurrent Peak Reverse Voltage	V_{RRM}	1200	$T_c=25^\circ\text{C}$	V
Surge Peak Reverse Voltage	V_{RSM}	1200	$T_c=25^\circ\text{C}$	V
Maximum DC Blocking Voltage	V_{DC}	1200	$T_c=25^\circ\text{C}$	V
Forward Current	I_F	44	$T_c \leq 25^\circ\text{C}$	A
		20	$T_c \leq 135^\circ\text{C}$	
		15	$T_c \leq 150^\circ\text{C}$	
Peak Forward Surge Current, 8.3ms Single Half Sine-wave Superimposed on Rated Load (JEDEC method)(Per leg)	I_{FSM}	140	$T_c=25^\circ\text{C}$, $T_p=8.3\text{ms}$, Half Sine Wave	A
Power Dissipation	PD	170	$T_c=25^\circ\text{C}$	W
Operating Junction Temperature Range	T_j	-55 ~ +175		$^\circ\text{C}$
Storage Temperature Range	T_{stg}	-55 ~ +175		$^\circ\text{C}$

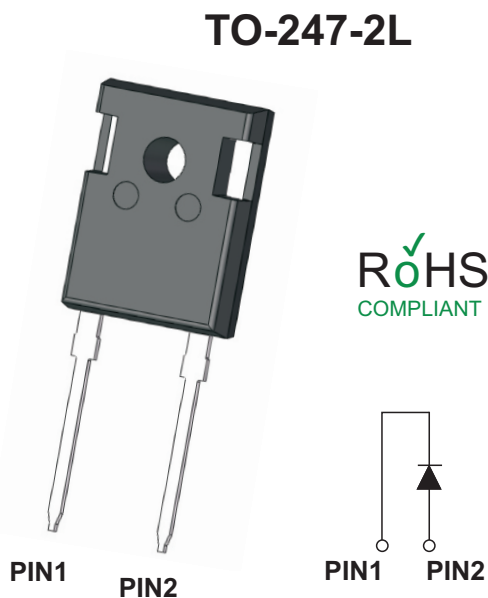



Electrical Characteristics

Ratings At 25°C Ambient Temperature Unless Otherwise Specified

Parameter	Symbols	Test Conditions	Min	Typ	Max	Units
Instantaneous forward voltage per leg	V_F	$I_F=15A, T_J=25^\circ C$ $I_F=15A, T_J=175^\circ C$		1.45 2.0	1.8 2.3	V
Reverse current per leg	I_R	$V_R=1200V, T_J=25^\circ C$ $V_R=1200V, T_J=175^\circ C$		8 40	100 500	μA
Total Capacitance	C	$V_R=0V, T_J=25^\circ C, f=1MHz$		960		pF
Total Capacitive Charge	Q_c	$V_R=800V, I_F=15A$ $di/dt=200A/\mu s, T_J=25^\circ C$		62		nC

Thermal Characteristics

Parameter	Symbols	TYP	Units
Thermal Resistance from Junction to Case	$R_{\theta JC}$	0.8	$^\circ C/W$

Typical Performance

Figure 1. Total Capacitance vs. Reverse Voltage

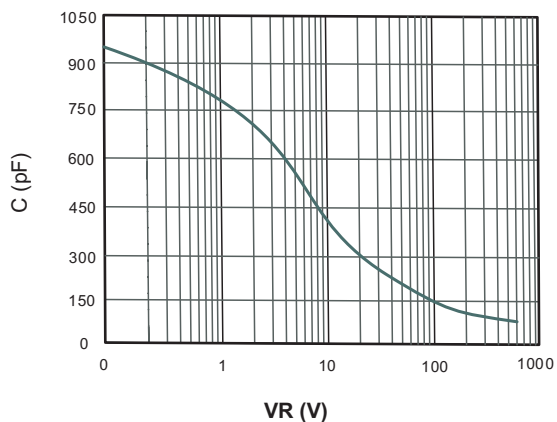

Figure 2. Total Capacitive Charge vs. Reverse Voltage

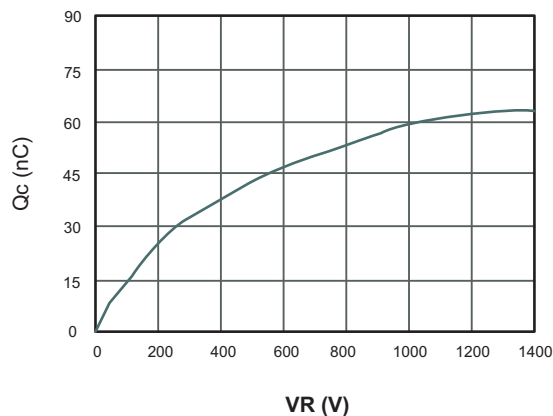



Fig.3 Typical Forward Current Derating Curve

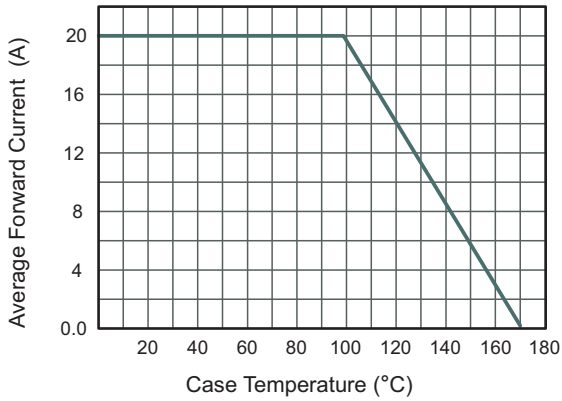

Fig.4 Power Dissipation

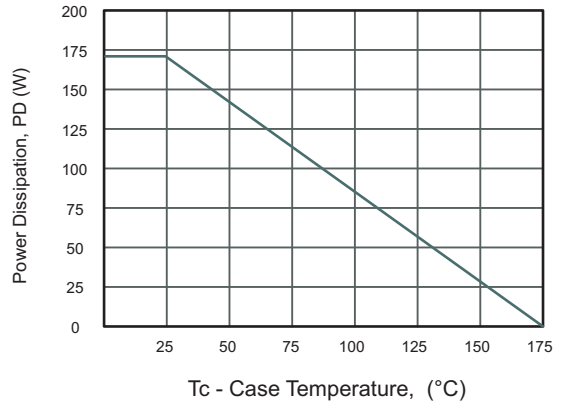

Fig.5 Typical Forward Characteristic(per leg)

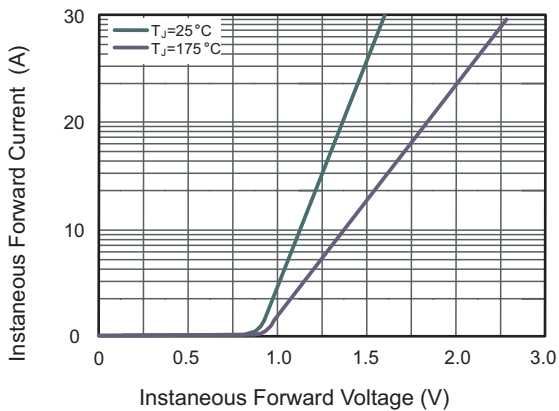

Fig.6 Typical Reverse Characteristics

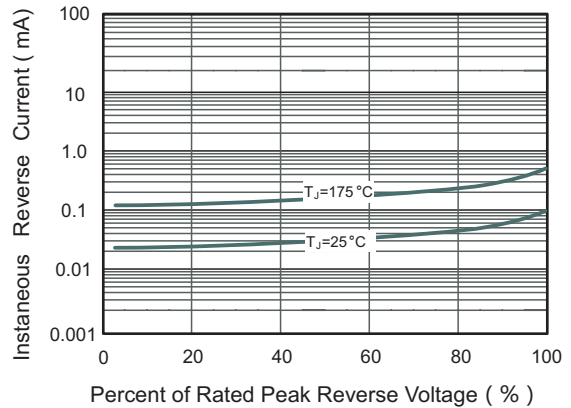

Fig.7 Max. Transient Thermal Impedance

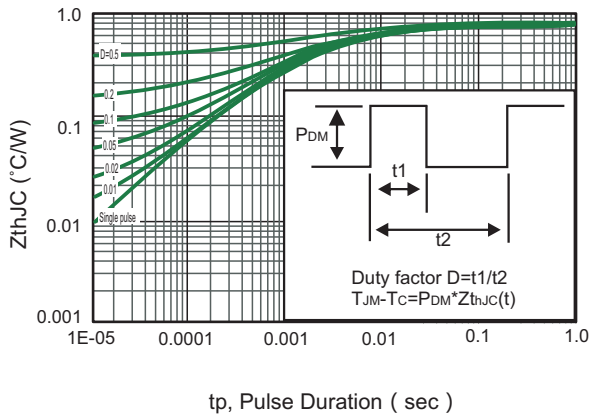
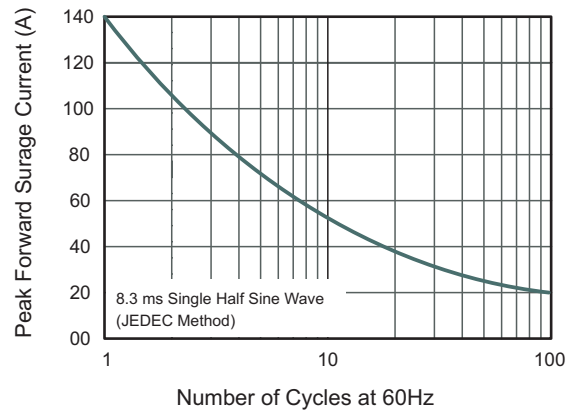

Fig.8 Maximum Non-Repetitive Peak Forward Surge Current





Package Outline
Through hole Package ; 2 leads

TO-247-2L

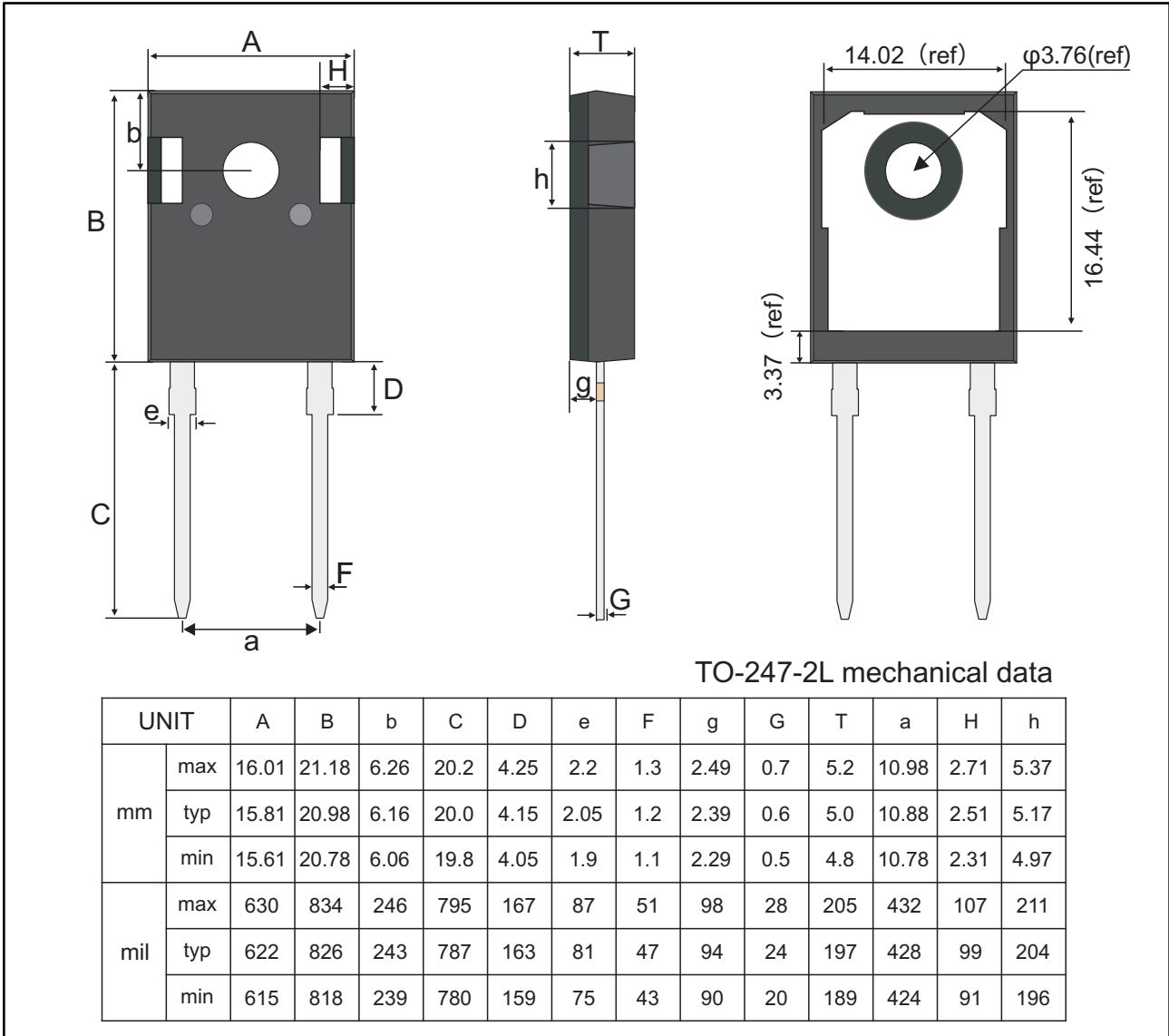

Marking

Type number	Marking code
SC15120W	SC15120W



Important Notice and Disclaimer

Jingdao Microelectronics reserves the right to make changes to this document and its products and specifications at any without notice.

Customers should obtain and confirm the latest product information and specifications before final, purchase or use.

Jingdao Microelectronics makes no warranty, representation or guarantee regarding the suitability of its products for any particular purpose, not does Jingdao Microelectronics assume any liability for application assistance or customer product design.

Jingdao Microelectronics does not warrant or accept any liability with products which are purchased or used for any unintended or unauthorized application.

No license is granted by implication or otherwise under any intellectual property rights of Jingdao Microelectronics.

Jingdao Microelectronics products are not authorized for use as critical components in life support devices or systems without express written approval of Jingdao Microelectronics.